



ASY Electronics (Jiaxing) Co., Ltd

Business inquiries: +86 181 5734 3325

E-mail: [sales@king-sen.com](mailto:sales@king-sen.com) Website: [www.asyjx.com](http://www.asyjx.com)

Address: Room 302, Building 11, No. 79 Jinsui Road, Economic and Technological Development Zone, Jiaxing , Zhejiang P.R. China

# Thermal gas mass flowmeter

## AI-FL general type Manual



### **Application area:**

Aerospace、 Semiconductor processing、  
Medical biochemistry、  
Electronic powered automobile、  
Ferrous metallurgy、 VEIS、  
the industrial gas production and related industries.



ASY Electronics (Jiaxing) Co., Ltd

Business inquiries: +86 181 5734 3325

E-mail: [sales@king-sen.com](mailto:sales@king-sen.com) Website: [www.asyjx.com](http://www.asyjx.com)

Address: Room 302, Building 11, No. 79 Jinsui Road, Economic and Technological Development Zone, Jiaxing , Zhejiang P.R. China

## Table of contents

I. Product Introduction .....	2
II. Product Features .....	2
III. Technical Parameters .....	2
IV. Mechanical Dimensions .....	3
V. Installation Method .....	5
VI. Wiring Instructions .....	7
VII. Operating Instructions .....	8
VIII. Product Selection .....	13
IX. Quality Assurance and After-Sales Service .....	17
X. Appendix MODBUS Protocol .....	15



## I. Product Introduction

The AI-FL universal thermal gas mass flow meter is an ultra-small thermal gas flow sensor designed and developed using an advanced microelectromechanical system (MEMS) flow sensing chip. This universal flow meter features high accuracy, high sensitivity, and strong anti-interference capabilities, making it suitable for measuring and controlling various small-flow-rate clean gases. Its ultra-small size allows it to be used in various pipe diameters, offering low cost, easy installation, and no need for temperature and pressure compensation. It can replace traditional volumetric or differential pressure flow meters.

## II. Product Features

- Employing a microelectromechanical system (MEMS) flow sensing chip, the sensor features high precision, high sensitivity, and strong anti-interference capabilities.
  - Zero-point stability of the sensor.
  - It has high accuracy and good repeatability within its measurement range.
  - Standard mechanical interface, easy to install.
  - RS485 communication output, standard MODBUS RTU protocol.
  - The LCD displays instantaneous and cumulative flow rates, which are clear, intuitive, and easy to read.
  - It can be equipped with a 4~20mA standard current signal output.
  - Ultra-compact size, dimensions: 90\*35\*127mm.

## III. Technical Parameters

working power supply	DC24V/2.5W	Accuracy (%)	±(2.0+0.2FS)
----------------------	------------	--------------	--------------

medium temperature	-10~55 °C	Zero Drift	± 20m V
Work pressure	≤1.6 MPa ( default ), higher pressure ratings can be customized .	show	Instantaneous traffic, cumulative traffic
Output method	4-20mA / R S485 optional	Communication Protocol	Modbus R tu ( RS485 output)
Mechanical connection	G3/ 4 external thread, G1/2 external thread, G3/4 external thread	Response time (ms)	50-1000 ms
Storage temperature	-10~65°C	humidity	<95%RH (no frost, no ice)

Note: The above data were measured at 25°C, 101.32 kPa, and in dry air.

**Minimum measurable flow rate: 5 NL/min**

**Maximum measurable flow rate: 1000 NL/min**

## IV. Mechanical Dimensions

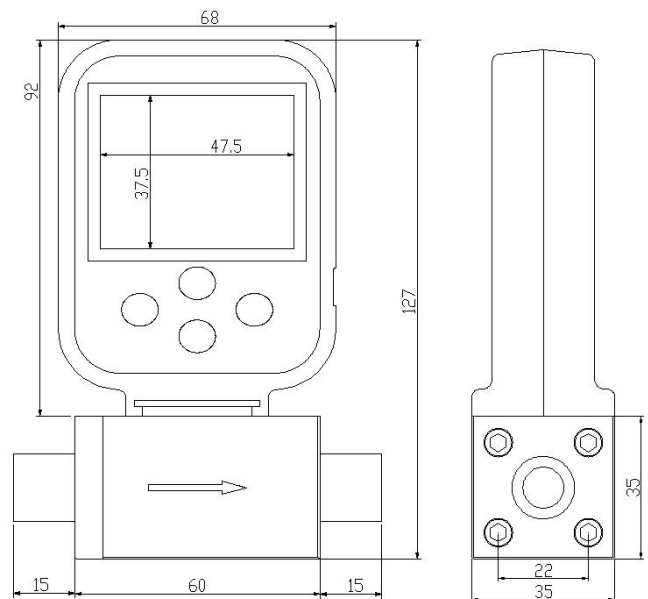
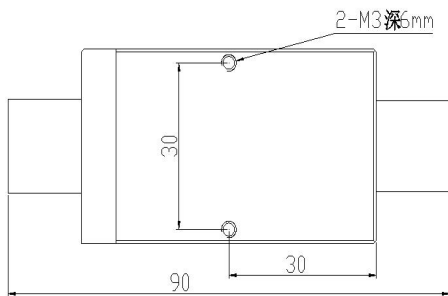

Mechanical interface connection dimensions	
DN 10	G3/8 external thread
DN 10	NPT1/2 External Thread



### DN10 Outline Dimensions

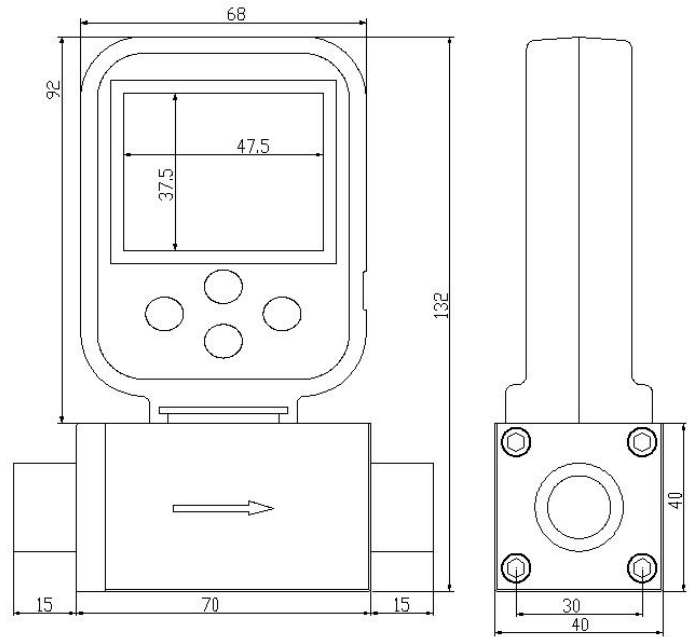
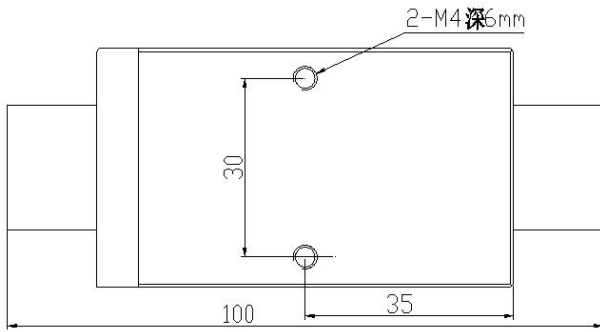

Mechanical interface connection dimensions	
DN 15	G1/2 External Thread
DN 20	G3/4 External Thread

### DN15/DN20 Outline Dimensions

**Standard connectors can be used for interface conversion as needed.**

Adapter	quick-connector	Pagoda connector

Mechanical interface connection dimensions	
G3/4 External Thread	NPT1/2 External Thread
G3/8 External Thread	G1/2 External Thread



## V. Installation Method

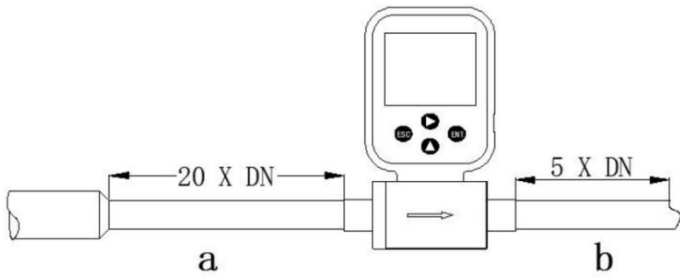
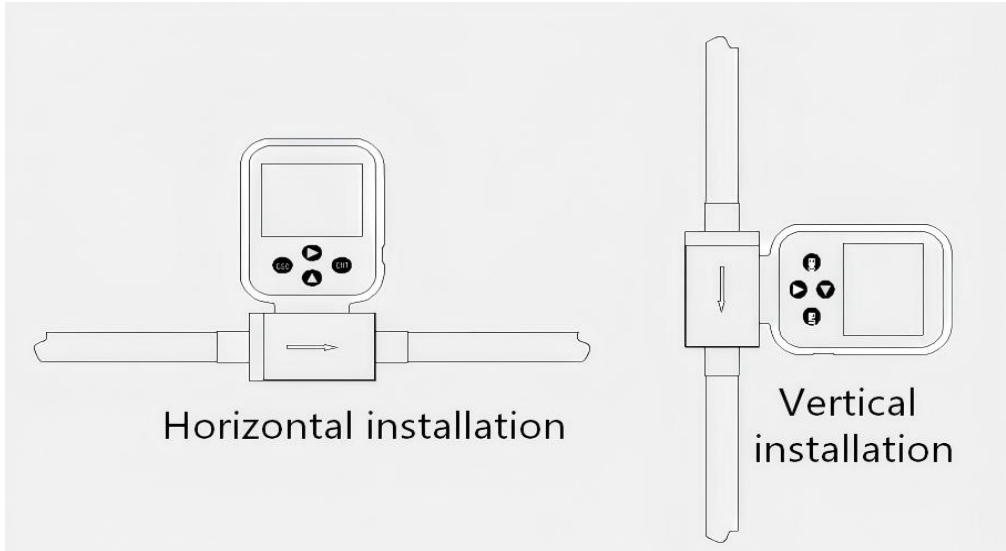

Reduced pipe diameter

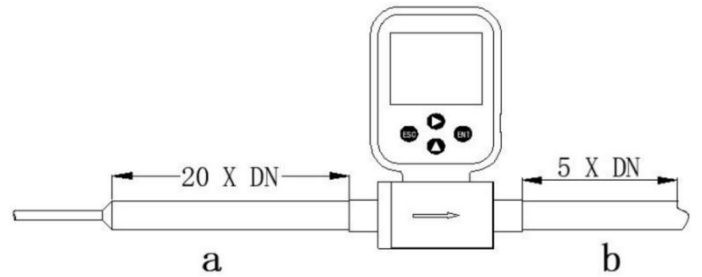

Expansion diameter

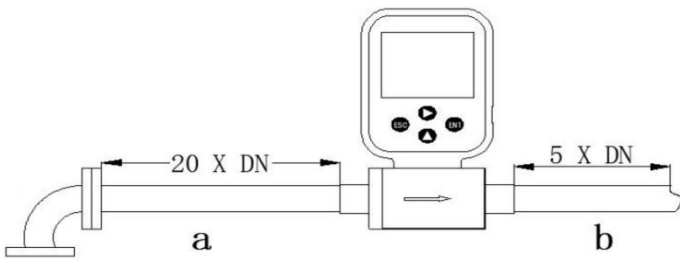

With 90-degree elbows or T-shaped pipes

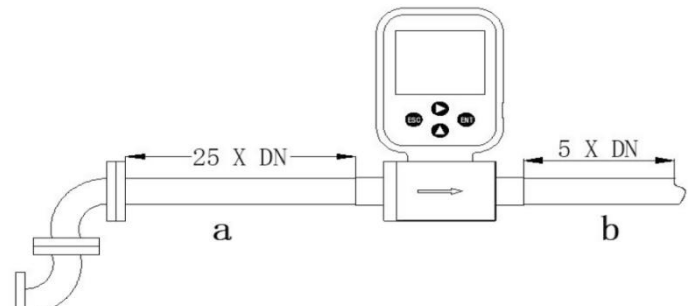

Pipe with two 90-degree bends

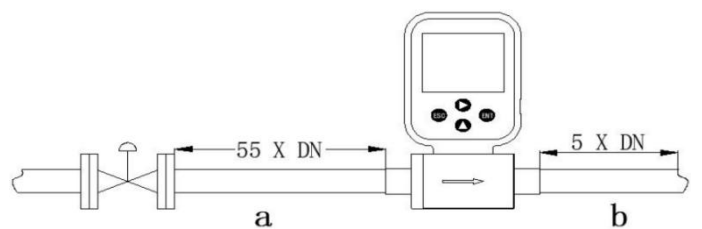
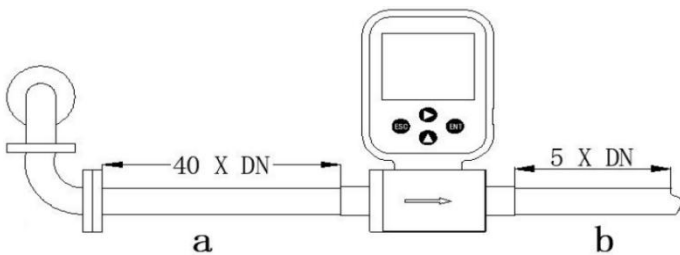



ASY Electronics (Jiaxing) Co., Ltd

Business inquiries: +86 181 5734 3325

E-mail: [sales@king-sen.com](mailto:sales@king-sen.com) Website: [www.asyjx.com](http://www.asyjx.com)

Address: Room 302, Building 11, No. 79 Jinsui Road, Economic and Technological Development Zone, Jiaxing , Zhejiang P.R. China

3-way pipe with two 90-degree bends

control valve



Notice!

**a = upstream straight pipe section b = downstream straight pipe section**

**Try to install the control valve and buffer shut-off valve after the thermal gas mass flow meter.**



Business inquiries: +86 181 5734 3325

E-mail: [sales@king-sen.com](mailto:sales@king-sen.com) Website: [www.asyjx.com](http://www.asyjx.com)

Address: Room 302, Building 11, No. 79 Jinsui Road, Economic and Technological Development Zone, Jiaxing , Zhejiang P.R. China

## VI. Wiring Instructions

4-core aviation wire description			
logo	meaning	logo	meaning
1 — — Red	24V+	3 — White	I+/RS485 communication
2 — — Black	24V-	4 — — Green/Yellow	I-/RS485 communication
Note: 4-20mA and RS485 outputs are optional.			

### Wiring instructions for 4-20mA current output

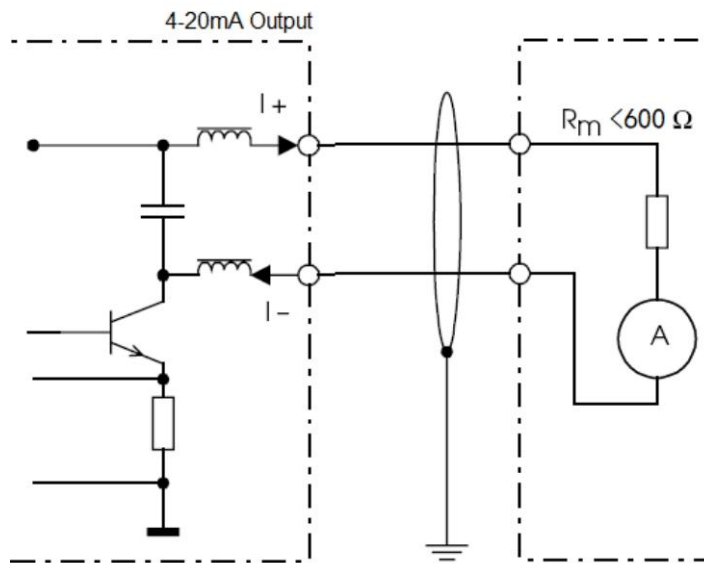

### RS485 bus wiring instructions

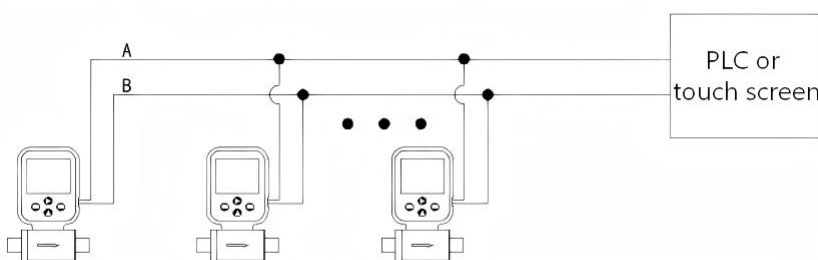

The default configuration for 485 bus communication is 32 units.

## VII. Operating Instructions

Button Instructions			
logo	meaning	logo	meaning
ESC	Cancel or exit the interface	▶	shift key
ENT	Confirm/Enter button	▲	Modify/Page Turn Key

The flow meter displays different information and the buttons function differently depending on the operating state. The following is a breakdown:

The user's operational purpose, and a detailed explanation of the flow meter interface content and operation process.

### Display menu interface

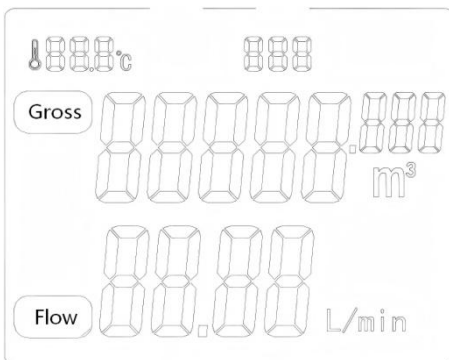

Total: Displays the cumulative total amount of gas, in m<sup>3</sup> (standard conditions).

Flow rate: Displays the instantaneous flow rate of the gas, in L /min (standard conditions).

Temperature: Displays the current ambient temperature (optional).

Address: Displays the current MODBUS address .

### Password verification interface



ASY Electronics (Jiaxing) Co., Ltd

Business inquiries: +86 181 5734 3325

E-mail: [sales@king-sen.com](mailto:sales@king-sen.com) Website: [www.asyjx.com](http://www.asyjx.com)







Address: Room 302, Building 11, No. 79 Jinsui Road, Economic and Technological Development Zone, Jiaxing , Zhejiang P.R. China



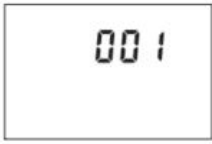
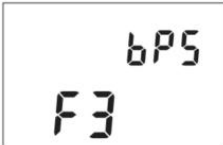

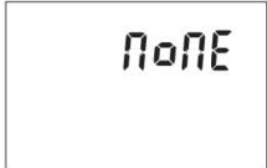

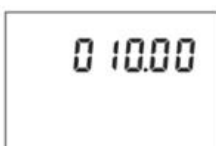

Press the ENT key to enter the password verification interface. At this point, the user needs to enter a specific password to access the instrument's settings menu. If the password is incorrect, the flow meter will return to metering mode. The default password is 11111.

When entering a password, the current input digit will flash. Press the shift key to move to the next digit, press the modify key to change the value of the current digit, and press the ENT key to confirm. If the password is correct, you can enter the settings menu. Press the modify/page up/down keys to switch between menus.











Settings interface		
Settings	interface	Sub-interface
Modbus address		
	<p>When entering a value, the current input digit is flashing. Press <b>the shift key</b> to move to the next digit, press <b>the modify key</b> to modify the value of the current digit, and press the <b>ENT</b> key to confirm the modification.</p> <p>Range: 1 - 255</p>	
baud rate		
	<p>Press the <b>Modify/Page Up</b> button to select the current baud rate, which can be 4800 , 9600 , 19200 , or 38400. Press <b>the ENT button</b> to confirm.</p>	
Check bit		
	<p>Press <b>the Edit/Page Up</b> button to select the checksum; options include none, odd, and event. Press <b>the ENT button</b> to confirm.</p>	
Calibration zero point		
	<p>Press the <b>ENT</b> key to calibrate the current zero point.</p>	
Gas correction factor		
	<p>When entering a value, the current input digit is flashing. Press <b>the</b></p>	

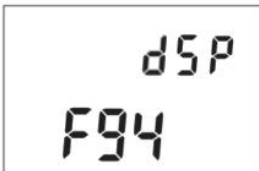

	<p><b>shift key</b> to move to the next digit, press <b>the modify key</b> to modify the value of the current digit, and press the <b>EN T</b> key to confirm the modification.</p>	
Response time settings		
	<p>Press the Edit/Page Up button to select the current response time. You can choose 125ms, 250ms, 500ms , or 1000ms . Press the ENT button to confirm.</p>	
High flow alarm value setting		
	<p>When inputting a value, the current input digit will flash. Press <b>the shift key</b> to move to the next digit, press <b>the modify key</b> to change the value of the current digit, and press the <b>EN T</b> key to confirm the modification. The flow meter will issue an alarm when the instantaneous flow rate exceeds the preset high flow alarm value. The alarm signal is the instantaneous flow rate and a flashing alarm icon. Settable range: 0.00~999.99 L/min.</p>	
Low flow alarm value settings		
	<p>When inputting a value, the current input digit will flash. Press <b>the shift key</b> to move to the next digit, press <b>the modify key</b> to change the value of the current digit, and press the <b>EN T</b> key to confirm the modification. The flow meter will issue an alarm when the instantaneous flow rate falls below the preset low flow alarm value. The alarm signal consists of the instantaneous flow rate and a flashing alarm icon. Settable range: 0.00~999.99 L/min.</p>	



Clear cumulative total		
	Press the EN T key to clear the current total.	
small signal resection		
	When entering a value, the current input digit flashes. Press <b>the shift key</b> to move to the next digit, press <b>the modify key</b> to modify the value of the current digit, and press <b>the ENT key</b> to confirm the modification. The small signal cutoff value is a percentage of the flow rate.	
Backlight settings		
	It can be set to 0 or 1. 1 indicates always on, and 0 means automatically turn off the backlight.	
Range setting		
	Maximum flow rate. Settable range: 0.0~ 9999.99 L/min.	



## VIII. Product Selection



AI-FL-

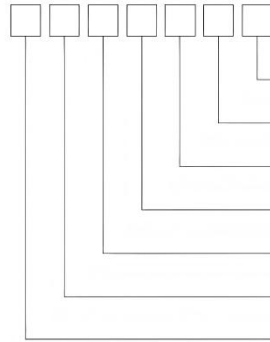

(See the table below for details)

Pressure rating(PO-1.6MPaP1 - Customized)

Type of medium

Output signal (A-4-20mA, R-RS485)

Mechanical interface

Maximum flow

Pipe diameters (10, 15, 20)

The material of the main body

Product Series	Body material	Pipe diameter	flow	Mechanical interface	Output signal	medium	Pressure level
AI-FL	F0	10	L200	GW1	A	AIR	P0

For example:

Model: AI-FL - F0 10L200GW1AAIRP0 Parameters: **AI-FL** : General purpose; **Body material** : F0 aluminum alloy; **Pipe diameter** : DN10; **Flow range** : 2-200L/min; **Mechanical interface** : G3/8 external thread; **Output signal** : 4-20mA; **Measuring medium** : air; **Pressure rating** : less than 1.6MPa

Body material	F0: Aluminum alloy (default); F1: 304 stainless steel ; F2: 316 stainless steel		
Pipe diameter	10	DN10	Flow measurement range: 2.8-280 L/min
	15	DN15	Flow measurement range 6-600L/min
	20	DN20	Flow measurement range 10-1000L/min
Maximum flow	L1 represents 1 L/min, L200 represents 200 L/min, and L1500 represents 1500 L/min.		
Mechanical	GW	1	G3/8 external thread



interface		(DN10)
	2	G1/2 external thread (DN15)
	3	G3/4 external thread (DN20)
GN indicates G internal thread; NW indicates NPT external thread; NT is a special custom thread; (default GW)		
Output signal	A: Indicates 4-20mA	
	R: Indicates RS485	
Media type	Measurement medium type: AIR is air (default), N2 is nitrogen, O2 is oxygen, CO2 is carbon dioxide, MG is mixed gas.	
Pressure level	P0: indicates $\leq 1.6$ MPa (default); P1: indicates a customized higher pressure rating.	

**Note: Flow rate measurement ranges are all based on air measurements.**

**Medium type: Air calibration is used to measure the range of other medium gases.**

Serial Number	gas	Conversion factor	Range percentage
1	Air	1.0	100%
2	Oxygen (O2)	0.9861	98.61%
3	Nitrogen N2	0.994	99.4%
4	Argon AR	1.4066	140.66%
5	Nitric oxide (NO)	0.9702	97.02%
6	Nitrogen dioxide (NO2)	0.7366	73.66%
7	Carbon dioxide (CO2)	0.7326	73.26%
8	Methane CH4	0.7147	71.47%
9	Ethane C2H6	0.4781	47.81%
10	Propane C3H8	0.3459	34.59%



## IX. Appendix MODBUS protocol

flow	0x003A ~0x003B	Revise	Not allowed
		Read	allow
Parameter Description	Current instantaneous flow rate of gas		
Data types	UINT 32		
Data representation	0x003A~0x003B constitute a UINT32 unsigned integer, representing the current gas flow rate; Flow rate $F = \text{value}(0x003A) * 65536 + \text{value}(0x003B)$ ; the value of F is the flow rate (L/min) * 1000. For example, if the flow rate is 20.34 L/min, then the value obtained through Modbus is $20.34 * 1000 = 20340$ .		
Total	0x003C~0x003E	Revise	allow
		Read	allow
Parameter Description	Total amount of gas flowing through		
Data types	UINT 32+ UINT 16		
Data representation	$V1 = \text{value}(0x003C) * 65536 + \text{value}(0x003D)$ ; $V2 = \text{value}(0x003E)$ ; Total amount $V = V1 * 1000 + V2$ ; where V1 is 32 bits, representing the integer part of the current total amount; V2 is 16 bits, representing the fractional part of the current total. Example: If the current total is 3452.245m, then the value obtained through Modbus is $3452 * 1000 + 245 = 3452245$ .		
Automatic zeroing	0x 00f0 (Write-only)	Revise	allow
		Read	Not allowed
Parameter Description	Force automatic zeroing operation. Note: Before performing this operation, ensure that the airflow in the flow meter pipeline is stationary.		
Data types	Specified data 0x AA55		
Data representation	For example, writing the specified data 0xAA55 into register 0x00F0 will complete the automatic zeroing.		



Total amount cleared	0x 00F2	Revise	allow
		Read	Not allowed
Parameter Description	Clear cumulative total		
Data types	Specified data 0x 0001		
Data representation	For example, writing the specified data 0x0001 into register 0x00F2 will clear the total amount.		
Write protection	0x 00FF	Revise	allow
		Read	Not allowed
Parameter Description	Enable write protection for registers; this is a one-time activation. Note: Write protection must be enabled before setting GCF, auto-zeroing, and clearing totals.		
Data types	Specified data 0x AA55		
Data representation	To modify GCF, you must first write 0xAA55 into the write protection register 0x00FF for the modification to succeed.		



## 10. Quality Assurance and After-Sales Service



Business Phone: 18157343325 Lila Xu

Technical Phone: 18057302496 Wailly Yang

Email: [sales@king-sen.com](mailto:sales@king-sen.com)

Official website: [www.asyjx.com](http://www.asyjx.com)

Address : Room 302, Building 11, No. 79 Jinsui Road, Economic and Technological Development Zone, Jiaxing , Zhejiang P.R. China

\*This information product images and technical data is for reference only, if subject to update without prior notice, the specific content of the right to interpret ASY Electronics (Jiaxing) Co., Ltd.

Adhering to the ISO9001 quality management and control system, this product is manufactured using brand-new raw materials and components and undergoes rigorous factory testing. Product quality and performance meet relevant standards and technical specifications. However, due to uncertainties that may arise during transportation or use, we commit to the following service guarantee terms:

Within one year from the date of product delivery, if the product you purchased malfunctions during normal use due to reasons other than improper use or human error...

We will repair any product damage caused by any factors free of charge.

Damage to the equipment caused by the following reasons during use is not covered by the free replacement or repair policy:

- Installation or use conditions that violate the relevant requirements and regulations in this manual;
- Incorrect or contrary to the relevant instrument installation, wiring, or usage specifications of the country in which it is located;
- This product may not be used in conjunction with other products that are electrically incompatible with it or that lack reliable quality assurance and valid certification.
- Self-disassembly or repair;
- Equipment that has been in use for more than one year may experience natural aging or wear and tear.
- Force majeure as defined by applicable law

For products within the warranty period, the user shall bear the cost of sending the product out, and we shall bear the cost of replacement or repair and return of the product.

If the product sent by the user is confirmed by us to be free from defects or damage, the user shall bear the relevant shipping and insurance costs.



ASY Electronics (Jiaxing) Co., Ltd

Business inquiries: +86 181 5734 3325

E-mail: [sales@king-sen.com](mailto:sales@king-sen.com) Website: [www.asyjx.com](http://www.asyjx.com)

Address: Room 302, Building 11, No. 79 Jinsui Road, Economic and  
Technological Development Zone, Jiaxing , Zhejiang P.R. China